



Save These Instructions for Future Reference



Vala

ALL CONNECTIONS TO BE CARRIED OUT BY A QUALIFIED ELECTRICIAN  
PLEASE READ CAREFULLY BEFORE STARTING INSTALLATION.



**WARNING**

Electronic Control Device

**ELECTRIC SHOCK HAZARD**  
This equipment is to be serviced by trained personnel only.

**Vala**

Save These Instructions for Future Reference

Electrical products can cause death, injury, or damage to property. Installation of this product must be carried out by a qualified electrician, in compliance with SANS 10142 or corresponding regulations of the country of installation. On completion of installation, the Certificate of Compliance must be updated.

**WARNING: TO AVOID FIRE, SHOCK OR DEATH**  
**TURN OFF POWER** AT CIRCUIT BREAKER OR FUSE AND TEST THAT THE POWER IS OFF BEFORE WIRING

ALL LUMINAIRES SUPPLIED AND TO BE INSTALLED ABOVE AND BELOW 5 METERS ARE IN COMPLIANCE WITH SANS 60598 SECTION 3.5.6 ACCORDING TO THE MANUFACTURER GUARANTEE AND WARRANTY

Regent Lighting reserves the right to change specifications modify designs and discontinue items without incurring obligation and whilst every effort is made to ensure that descriptions, specifications and other information in this catalogue are correct, no warranty is given in respect thereof and the company shall not be liable for any error therein.

www.regentlight.co.za

REGENT LIGHTING A DIVISION OF WAHL INDUSTRIES.

3 - 13 MAIN REEF SERVICE ROAD, CORNER  
SPRINGBOK AND MAIN REEF ROAD, INDUSTRIAL,  
JOHANNESBURG, SOUTH AFRICA.  
TEL : +27 11 474 0171

November 2017

**INSTALLATION INSTRUCTIONS**

PLEASE READ CAREFULLY BEFORE STARTING INSTALLATION.  
ALL CONNECTIONS TO BE CARRIED OUT BY A QUALIFIED ELECTRICIAN



**WARNING**

Electronic Control Device

**ELECTRIC SHOCK HAZARD**  
This equipment is to be serviced by trained personnel only.

**DO NOT CONNECT THE FITTING LIVE**

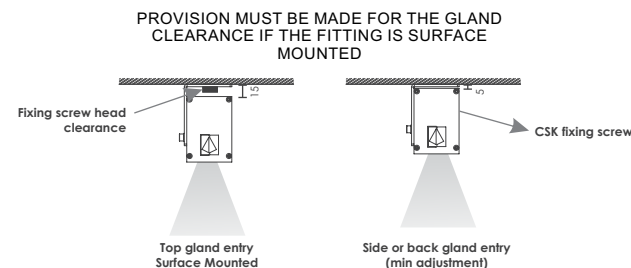
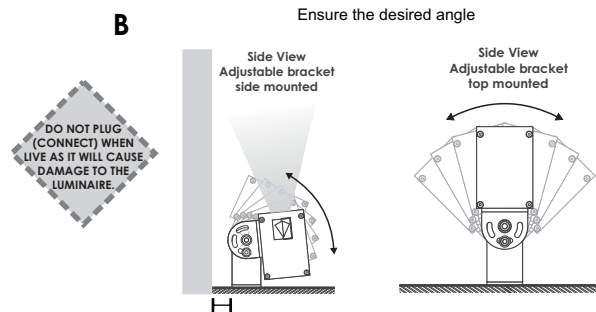
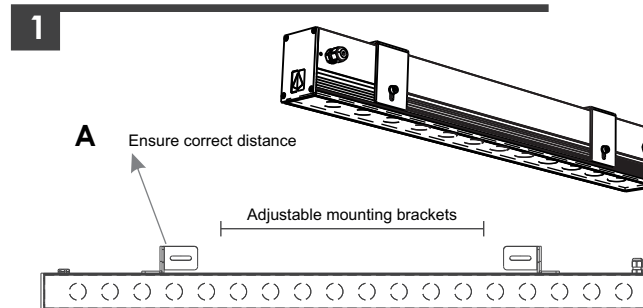

**Mounting instructions for surface mounting using both fixed and adjustable mounting brackets from the side and top of the fitting.**

**Requirements:**

- Be sure the electricity to the system you are working on is turned off.
- x2 Stainless steel screws/wall plugs required for mounting of the Vala Accent Light.
- x1 IP rated connector box.

**1. A.** Select the required position for the luminaire and drill the required mounting points.

**B.** Ensure the mounting brackets are the correct distance and desired angle from any surface (please note that the mounting brackets are adjustable in length on the side of the fitting), via the allen stainless steel screws using an allen key.



## Important Safety Instructions

- This product should be installed by a competent person i.e. Qualified electrician.
- This product requires a constant stable electrical supply 220V - 240V VAC 50Hz - alternating current.
- The light source of this luminaire is not replaceable, when the light source reaches its end of life the whole luminaire shall be replaced or service by the manufacturer
- This product could be HAZARDOUS if not used correctly, it could cause electric shock, serious bodily harm or death.
- This product is not a toy, please keep away from children. This product may contain small parts that can be swallowed.



- If the external flexible cable or cord of this luminaire is damaged, it shall be exclusively replaced by the manufacturer to avoid hazard.
- Any modifications of this product after supply will result in the guarantee being void.
- Spare parts may become unavailable over time. Items can vary slightly from the picture on the carton
- Coastal humidity can affect the longevity of the light fitting over time.
- Be sure to follow the steps in the order given.
- Read instructions carefully.

2

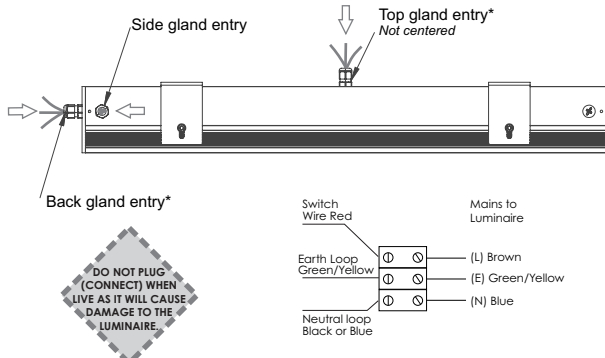

2. Connect the Switched Active (S/A), Neutral (N) and Earth (E) cable(s) to the cable tail provided using an IP rated connector block, to the desired cable gland, according to the mounting.

SWITCHED ACTIVE – (Red or Brown) to terminal marked L  
 NEUTRAL – (Black or Blue) to terminal marked N  
 EARTH – (Green/Yellow) to terminal marked.

\*NB: Ensure enough gland clearance when mounting. Top gland requires clearance when using the surface mount bracket.

**All fittings to be supplied with a cable tail, therefore no internal connections are required.**

3

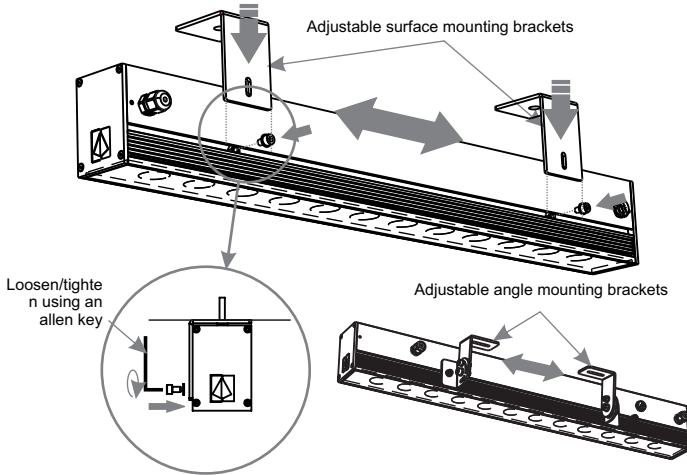

3. Fix the surface mounting bracket to the surface with the screws/wall plugs (not supplied).

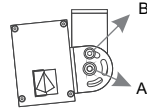

Adjustable bracket\*:  
 Adjust the adjustable bracket to the desired angle, by loosening/tightening bolts A and B.

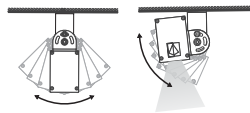

4

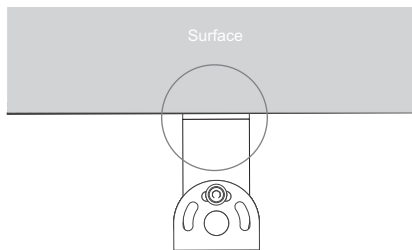

4. Ensure that there are no exposed conductors, loose strands or trapped insulation between the bracket and the mounting surface.

5

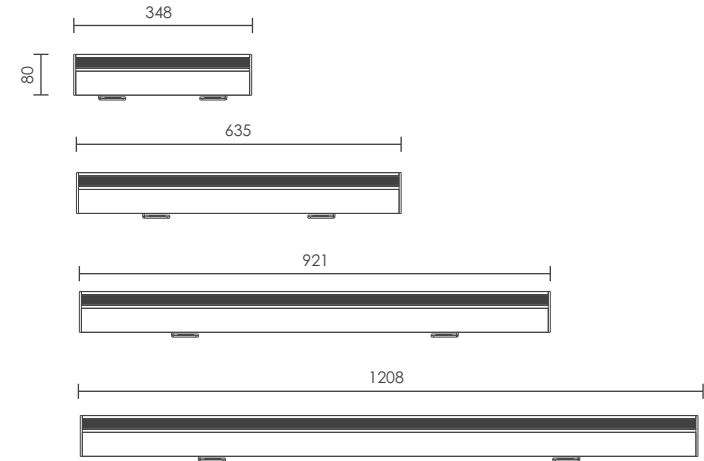

5. Switch on powder supply.

6

6. If the control gear is integrated, the fitting cannot be maintained or serviced and therefore the entire fitting will need to be replaced.

For replacement of the fitting, please kindly contact Regent Lighting.



**REGENT**  
 LIGHTING  
 SOLUTIONS

